

8806 Power Tube

Linear Beam Power Tube

CERMOLOX®
High Gain-Bandwidth Products
Full Input to 400 MHz
Ten Kilowatt Peak Sync Output Through
VHF-TV Band with 14.7 dB Gain
Ten Kilowatt Power Output in FM
Broadcast Service with 24 dB Gain

The 8806 is designed specifically to meet the high linearity, high gain requirements of VHF-TV and FM service and for communication equipment to 400 MHz.

In VHF-TV service at 220 MHz, the 8806 will deliver a full ten kilowatts of peak sync output at a gain of 14.7 dB. In FM broadcast service the 8806 will deliver ten kilowatts power output with a gain of 24 dB.

Rated for full input for the VHF-TV band and for other service to 400 MHz, the 8866 can be readily circuited for these frequencies. The 8808 and available variants are also well suited for other applications such as SSB, CW, pulsed RF or modular service.

Its sturdy, CERMOLOX construction and thoriated tungsten, mesh filament minimize tube inductances and feed-thru capacitances. Its coaxial, forced-air-cooled radiator reduces noise to a minimum and insures against spurious outputs. These features make possible the use of simple, economical, broadband circuit techniques in VHF and UHF operation.

This data sheet gives application information unique to the BURLE 8806. Important additional information of a general nature, applicable to tubes to this type, is given in the following publications:

- TP-105 Application Guide for BURLE Power Tubes
- TP-117 Handling and Operating Considerations when Using BURLE Broadcast-Type Tetrodes
- TP-118 Application Guide for Forced Air Cooling of BURLE Power Tubes

Close attention to the instructions contained therein will assure longer tube life, safer operation, less equipment downtime and fewer tube handling accidents.

For specific information or application assistance, contact your nearest BURLE Sales Representative or write Power Tube Marketing, BURLE INDUSTRIES, INC., 1000 New Holland Ave., Lancaster, PA 17601-5688.

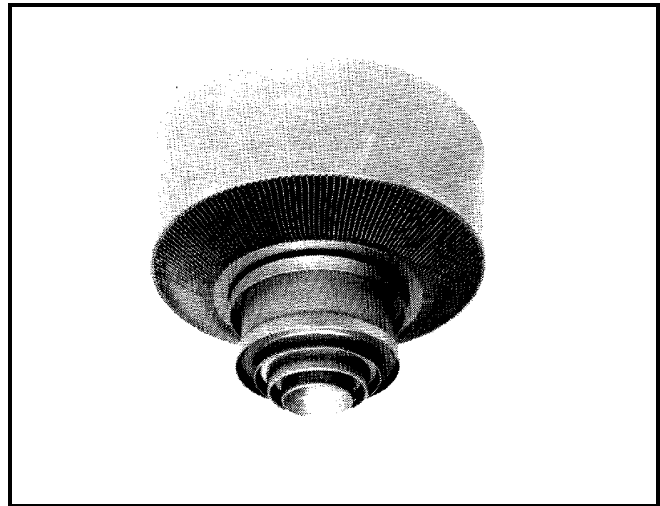

General Data

Electrical

Filamentary Cathode

Type	Thoriated-Tungsten Mesh		
Voltage ¹ (ac or dc)	5.7	typ.	V
	6.0	max.	V

Current:

Typical value at 5.7 volts ²	115		A
Maximum value for starting			
Even momentarily	300		A

Cold resistance 0.005 ohms

Minimum heating time³ 15 s

Mu-Factor:⁴

Grid No.2 to Grid No. 1 12.5

Direct Interelectrode Capacitances:

Grid No. 1 to plate⁵ 0.40 max. pF

Grid No. 1 to filament 70 pF

Plate to Filament⁵ 0.05 max. pF

Grid No. 1 to grid No. 2 90 pF

Grid No. 2 to plate 13.5 pF

Grid No. 2 to filament⁶ 2.5 max. pF

Mechanical

Operating Attitude Vertical, either end up

Overall Length 138.43 mm (5.45 in) max.

Greatest Diameter 156.72 mm (6.17 in) max.

Terminal Connections See Dimensional Outline

Socket CD 89-088⁷ or equivalent

Chimney 8823⁷ or equivalent

Radiator Integral part of tube

Weight (Approx.) 4.54 kg (10 lbs)



General Data (Cont'd)

Thermal

Seal Temperature ⁸ (Plate, grid No.2, grid No.1, filament-cathode and filament)	250	max.	°C
Plate-Core Temperature ⁸	250	max.	°C

Characteristic Range Values

Parameter	Min.	Max.	Units
Filament Current ¹⁶	106	126	A
Direct Interelectrode Capacitance: G ¹ to plate ⁵	-	0.4	pF
G ¹ to filament	68	72	pF
Plate to filament ⁵	-	0.05	pF
G ¹ to G ²	82	99	pF
G ² to plate	13	14	PF
G2 to filament ⁶	-	2.5	PF
Cut-Off G ¹ Voltage ^{14, 16}	70	155	V
Zero-Bias Plate Current ^{15, 16}	5.0	-	A
Grid-No.1 Voltage ^{16 17}	39	87	V

RF Power Amplifier & Osc. - Class AB Telegraphy⁹ and RF Power Amplifier - Class AB FM Telephony⁷ Maximum CCS Ratings, Absolute-Maximum Values

	Up to 400 MHz		
DC Plate Voltage ¹⁰	8000		V
DC Grid-No.2 Voltage ⁹	1650		V
DC Grid-No.1 Voltage ⁹	-450		V
DC Plate Current	4.0		A
DC Grid-No.1 Current	500		mA
Grid-No.1 Input	50		W
Grid-No.2 Input	150		W
Plate Dissipation	12,500		W

Maximum Circuit Values

Grid-No.1-Circuit Resistance Under Any Conditions:	
With fixed bias	5000 ohms
With cathode bias	Not recommended
Grid-No.2-Circuit Impedance	See note 9
Plate-Circuit Impedance	See note 10

Calculated CCS Operation

In Grid-Drive Circuit at 108 MHz			
DC Plate Voltage	6500		V
DC Grid-No.2 Voltage	1200		V
DC Grid-No.1 Voltage ¹¹	-114		V
DC Plate Current	2.75		A
DC Grid-No.2 Current	85		mA
DC Grid-No.1 Current	115		mA
Drive Power Output (Approx.)	40		W
Output Circuit Efficiency (Approx.)	97		%
Useful Power Output	10,000		W

Typical CCS Operation

In a Grid-Drive Circuit measured at 7.0 MHz			
DC Plate Voltage	7000		V
DC Grid-No.2 Voltage	1500		V
DC Grid-No.1 Voltage ¹¹	-140		V
DC Plate Current	2.2		A
DC Grid-No.2 Current	170		mA
DC Grid-No.1 Current	180		mA
Drive Power Output (Approx.)	82		W
Grid Loading Resistance	1000		ohms
Output Circuit Efficiency	97		%
Useful Power Output	10,000		W

RF Power Amplifier

Class B Television Service⁹

Synchronizing-level conditions per tube unless otherwise specified

Maximum CCS Ratings, Absolute-Maximum Values

DC Plate Voltage ¹⁰	8000	V
DC Grid-No.2 Voltage ⁹	1650	V
DC Grid-No.1 Voltage ⁹	-450	V
DC Plate Current	5	A
Plate Dissipation	12,500	W
Grid-No.2 Input	150	w
Grid-No.1 Input	50	w

Calculated Typical CCS Operation

In Cathode-Drive Circuit at 216 MHz, BW = 6.3 MHz ¹³		
DC Plate Voltage	6500	V
DC Grid-No.2 Voltage	1000	V
DC Grid-No.1 Voltage ¹²	-60	V
DC Plate Current:		
Synchronizing level	3.15	A
Pedestal level	2.40	A
DC Grid-No.2 Current:		
Synchronizing level	50	mA
Pedestal level	38	mA
DC Grid-No.1 Current:		
Synchronizing level	270	mA
Pedestal level	205	mA
Driver Power Output:		
Synchronizing level	340	W
Pedestal level	190	W
Output Circuit Efficiency	90	%
Useful Power Output:		
Synchronizing level	10,800	W
Pedestal level	6050	W

1. Measured at the tube terminals. For accurate data the ac filament voltage should be measured using an accurate RMS type meter such as an iron-vane or thermocouple type meter. The dc voltage should be measured using a high input impedance type meter. For high-current, low-voltage filaments such as are used in the 8806 tube, it is recommended that the filament current be monitored, since very small changes in resistance can produce misleading changes in voltage. For maximum life, the filament power should be regulated at the lowest value that will give stable performance. For those applications where hum is a critical consideration, dc filament or hum-bucking circuits are recommended. See also Application Note TP-117.
2. The characteristic range of current at 5.7 volts is from 106 to 126 amperes. It is recommended that an additional six amperes be available to allow for the normal reduction of filament resistance with life. Thus, the filament supply should be designed for a mean value of 132 amperes at 5.7 volts.
3. Sequence for applying voltage is as follows:
 - Filament
 - Bias
 - Plate
 - Screen
 - RF Drive
4. For plate voltage = 2000 V, grid-No.2 voltage = 1375 V, and plate current = 6.0 A.
5. With external flat metal shield 200 mm (8") in diameter having a center hole 76 mm (3") in diameter. Shield is located in plane of the grid-No.2 terminal, perpendicular to the tube axis and is connected to grid No.2.

6. With external flat metal shield 200 mm (8") in diameter having a center hole 60 mm (2-3/8") in diameter. Shield is located in plane of the grid-No.1 terminal, perpendicular to the tube axis and is connected to grid No.1.
7. As manufactured by: Jettron Products Inc., 65 Route 10, P.O. Box 337, East Hanover, NJ 07938.
8. See Dimensional Outline for Temperature Measurement points. The value of 250°C for plate core temperature is the average of three readings taken 1200 apart around the anode core. No one reading may exceed 275°C.
9. See TP-1 05.
10. The maximum voltage ratings must be modified for operation at altitudes higher than sea level and for temperatures in excess of 20°C in accordance with the curves of **Figure 3**.
The maximum fault energy that can be dissipated within the tube is approximately 100 joules. Therefore, the energy available for a high-voltage arc or fault must be limited to this value by means of current limiting resistors or fault-protection circuitry. This is especially important where high stored energy and large capacitors are used. For typical 10,000 watt TV transmitters, series resistor values are:
Plate - Thirty ohms minimum is required in high capacitance power supplies for video service.
Screen - Fifty ohms minimum.
Grid - Fifty ohms,
For additional information see TP-105 Application Guide for BURLE Power Tubes
11. Adjusted for $I_{bo} = 200$ mA.
12. Adjusted for $I_{bo} = 500$ mA.
13. The bandwidth of 6.3 MHz is calculated at the -0.72 dB power points of a double tuned output circuit using two times the tube output capacity and a damping factor of ~1.5 as shown in **Figure 4**.
14. With dc plate voltage = 8000 V, dc grid-No.2 voltage = 1000 V and the dc grid-No.1 voltage adjusted to 20 mA plate current.
15. With dc plate voltage = 2000V, dc grid-No.2 voltage 1500V, and the grid-No.1 voltage pulsed to zero volts.
16. With 5.7 V ac applied to the filament.
17. With dc plate voltage = 2000V, dc grid-No.2 voltage = 1250 V, and the dc grid-No.1 voltage adjusted for dc plate current = 1.0 A.

Safety Precautions

Protection circuits serve a threefold purpose: safety of personnel, protection of the tube in the event of abnormal circuit operation, and protection of the tube circuits in the event of abnormal tube operation.

Power tubes require mechanical protective devices such as interlocks, relays, and circuit breakers. Circuit breakers alone may not provide adequate protection in certain power-tube circuits when the power-supply filter, modulator, or pulse-forming network stores much energy. Additional protection may be achieved by the use of high-speed electronic circuits to bypass the fault current until mechanical circuit breakers are opened. These circuits may employ a controlled gas tube, such as a thyratron or ignitron, depending on the amount of energy to be handled.

Operating voltages applied to this device present a shock hazard and appropriate precautions should be taken.

Great care should be taken during the adjustment of circuits. The tube and its associated apparatus, especially all parts which may be at high potential above ground, should be housed in a protective enclosure. The protective housing should be designed with

interlocks so that personnel cannot possibly come in contact with any high-potential point in the electrical system. The interlock devices should function to break the primary circuit of the high-voltage supplies and discharge high-voltage capacitors when any gate or door on the protective housing is opened, and should prevent the closing of this primary circuit until the door is again locked.

A time-delay relay should be provided in the plate-supply circuit to delay application of plate voltage until the filament has reached normal operating temperature.

An interlocking relay system should be provided to prevent application of plate voltage prior to the application of sufficient bias voltage otherwise, with insufficient bias, the resultant high plate current may cause excessive plate dissipation with consequent damage to the tube. RF load shorts or other causes of high output VSWR may also cause high dissipations, excessive voltage gradients, or insulator flashover. The load VSWR should be monitored and the detected signal used to actuate the interlock system to remove the plate voltage in less than 10 milliseconds after the fault occurs.

Forced Air Cooling

Cooling air flow is necessary to limit the anode-core and terminal-seal temperatures to values that will assure long reliable life. A sufficient quantity of air should be directed past each of these terminals so that its temperature does not approach the absolute-maximum limit. The absolute-maximum temperature rating for this tube is 250° C. It is recommended that a safety factor of 25° to 50° be applied to compensate for all probable system and component variations throughout life.

The cooling air must be delivered by the blower through the radiator and at the terminal seals during the application of power and for a minimum of three minutes after the power has been removed.

To Cathode-Filament and Filament Terminals - A sufficient quantity of air should be blown directly at these terminals so that their temperature does not approach the absolute-maximum limit of 2500 C. A value of at least 60 cfm is recommended.

The Cooling Characteristic Curve, **Figure 6**, indicates the air flow and pressure requirements of a system sufficient to limit the core temperature to specific values for various levels of plate dissipation.

Because the cooling capacity of air varies with its density, factors must be applied to the air flow to compensate for operation at altitude or in high temperature environments.

During Standby Operation -Cooling air is required when only the filament voltage is applied to the tube.

For further information on forced air cooling, see TP-105 and also TP-118 Application Guide for Forced Air Cooling of BURLE Power Tubes."

Mounting

See the preferred mounting arrangements in **Figure 8**. For other arrangements, cavity-type mounting for multiple-ring terminal-type tubes may be constructed by using either fixed or adjustable contact rings of finger contact strips in the transverse plane as described in TP-105.

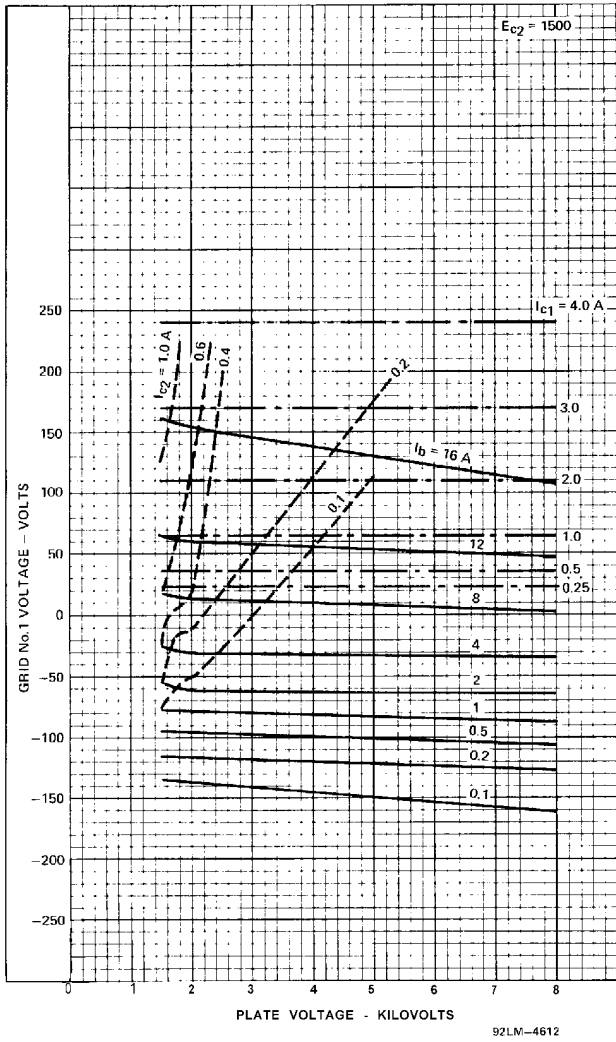

Figure 1 - Typical Constant Current Characteristics
 $E_{c2} = 1500\text{V}$

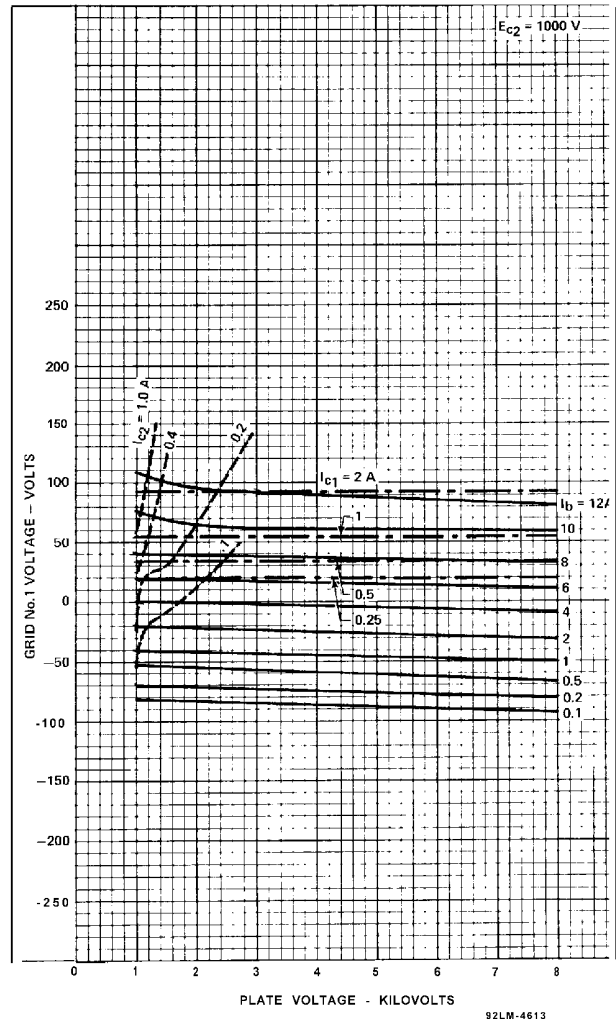

Figure 2 - Typical Constant Current Characteristics
 $E_{c2} = 1000 \text{ V}$

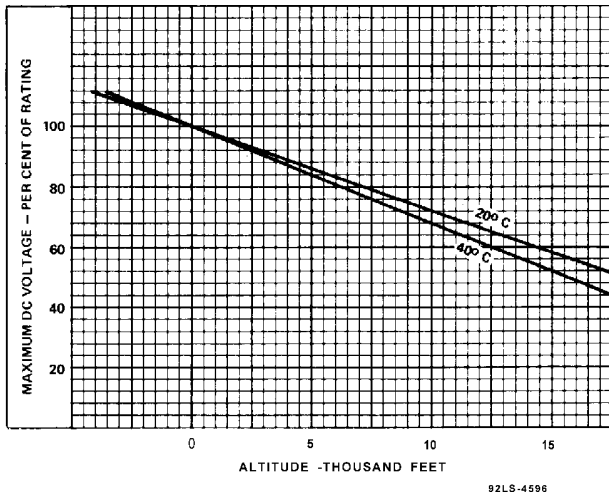

Figure 3 - Maximum DC Voltage with Respect to Altitude

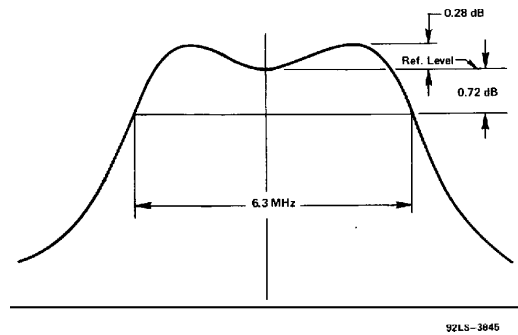
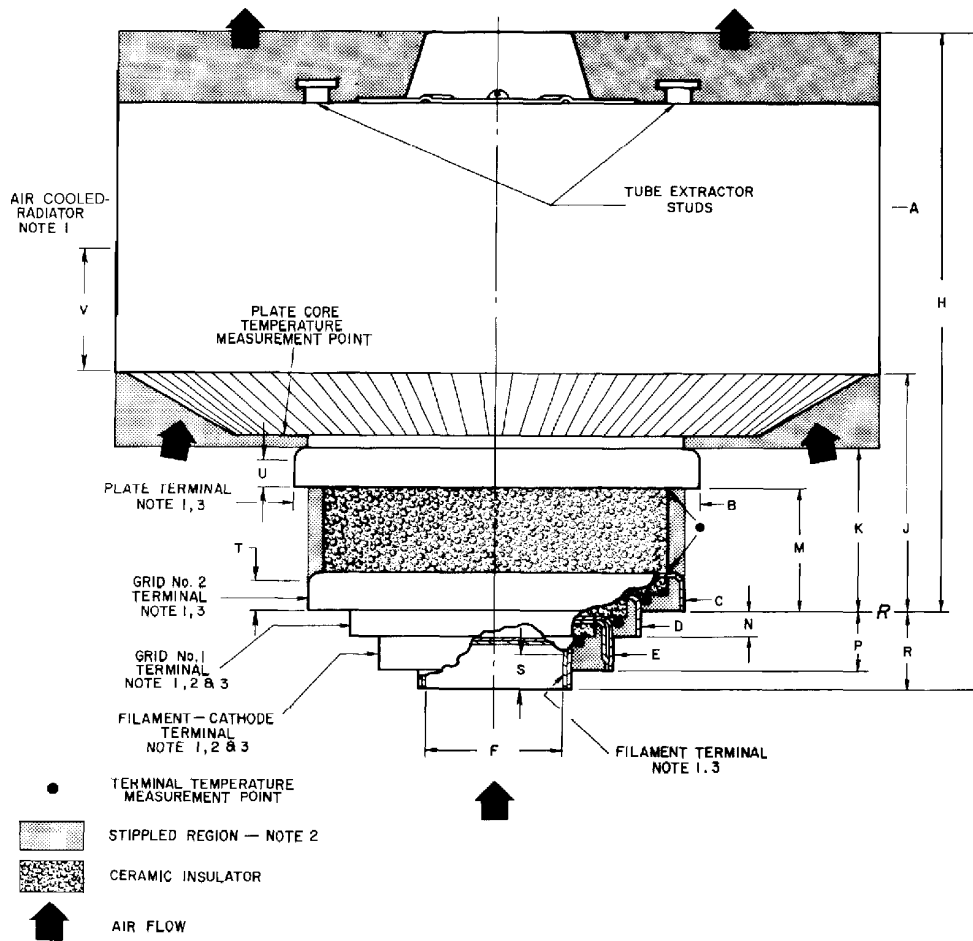

Figure 4 - Bandwidth Calculation



**Figure 5 - Dimensional Outline
Tabulated Dimensions**

Dimension	Millimeters	Inches	Notes
A Dia.	155.83±.88	(6.135±.035)	1,3
B Dia.	82.30±.25	(3.240 ± .010)	1,3
C Dia.	76.91 + .36	(3.028 ± .014)	1,3
D Dia.	58.90+.30	(2.319±.012)	1,3
E Dia.	46.99 ± .25	(1.850±.010)	1,3
F Dia.	30.48 ± .25	(1.200 ± .010)	1,3
G	136.4 ± 2.0	(5.370 ± .080)	
H	118.65±1.2	(4.670+.050)	
J	50.55 ± 1.01	1.990 ± .040)	
K	35.05 ± .76	1.380 ± .030)	
M	25.53 ± .51	(1.005 ± .020)	
N	5.08 ± .63	(0.200 ± .025)	

P	12.06+.76	0.475+ .030)	
R	16.51 ± .76	(0.650 ± .030)	
S	5.59 mm	(0.220 mm)	1
T	5.59 mm	(0.220 mm)	1
U	4.95 mm	(0.195 mm)	1
V	50.8 ref	(2.000 ref)	1

Note 1 - The diameter of each terminal is maintained only over the indicated minimum length of the contact surface.

Note 2 - Keep all stippled regions clear. In general, do not allow contacts to protrude into these annular regions, If special connectors are required which may intrude on these regions, contact BURLE Power Tube Application Engineering, Lancaster, PA 17601-5688.

Note 3 - With the plate terminal and the cathode-filament terminal used as reference, the other terminals will measure less than 0.040(1.02 mm) total indicator run-out (TIR).

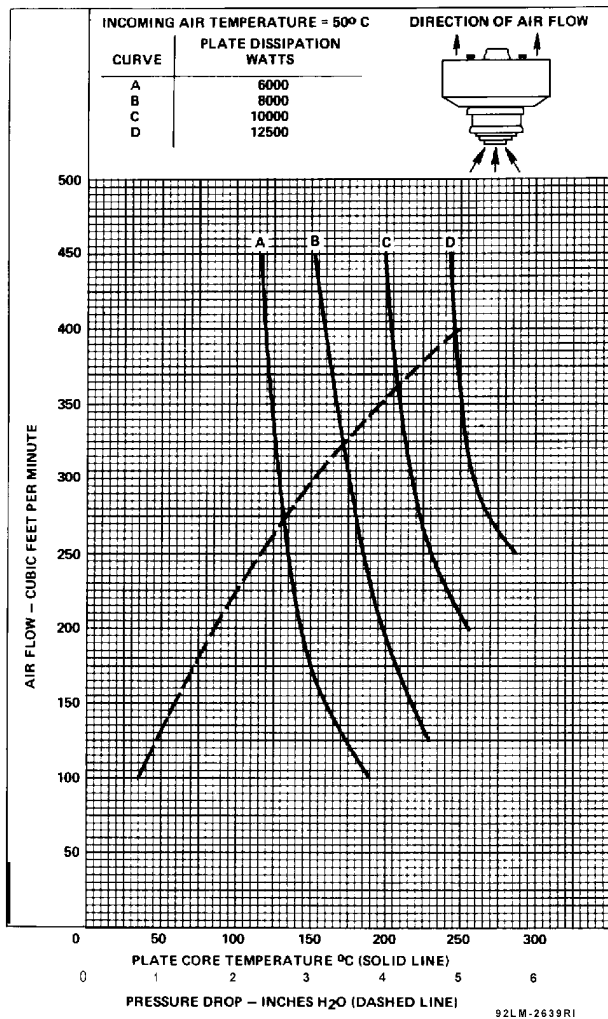

Figure 6 - Typical Cooling Characteristics

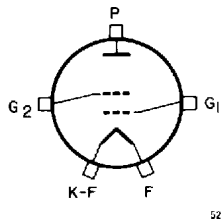

Figure 7 - Terminal Diagram

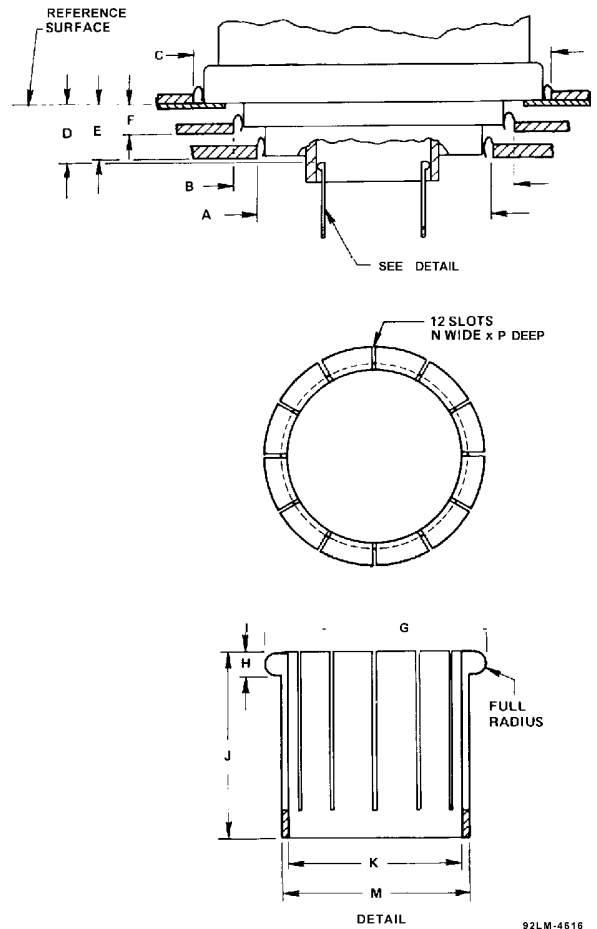

Figure 8 - Preferred Mounting Arrangement Tabulated Dimensions

Dimension	Millimeters	Inches	Notes
A Dia.	51.82	2.040	1
B Dia.	63.75	2.510	1
C Dia.	81.79	3.220	1
D Dia.	12.07	0.475	
E Dia.	10.92	0.430	
F Dia.	5.46	0.215	
G	30.99	1.220	2
H	3.18	0.125	
J	25.40	1.000	3
K	20.32	0.800	
M	25.40	1.000	
N	1.58	0.062	
P	19.05	0.75	

Note 1 - The tolerance for the indicated dimension is:
 plus 0.25 mm (0.010 inch) minus 00 mm (00 inch)

Note 2 - The tolerance for the indicated dimension is:
 plus 0.05 mm (0.002 inch) minus 00 mm (00 inch)

Note 3 - The tolerance for the indicated dimension is:
 minimum (minimum)

Note 4 - Finger stock is No.97-135A, as made by:
 Instrument Specialties Company, P. O. Box A,
 Delaware Water Gap, PA 18327.

Note 5- Sockets and chimneys are available in production quantities from: Jettron Products Inc., 65 Route Ten, P.O.Box 337, East Hanover, NJ 07938.

Supplier Socket No. Chimney No.
 Jettron CD 89-088 8823

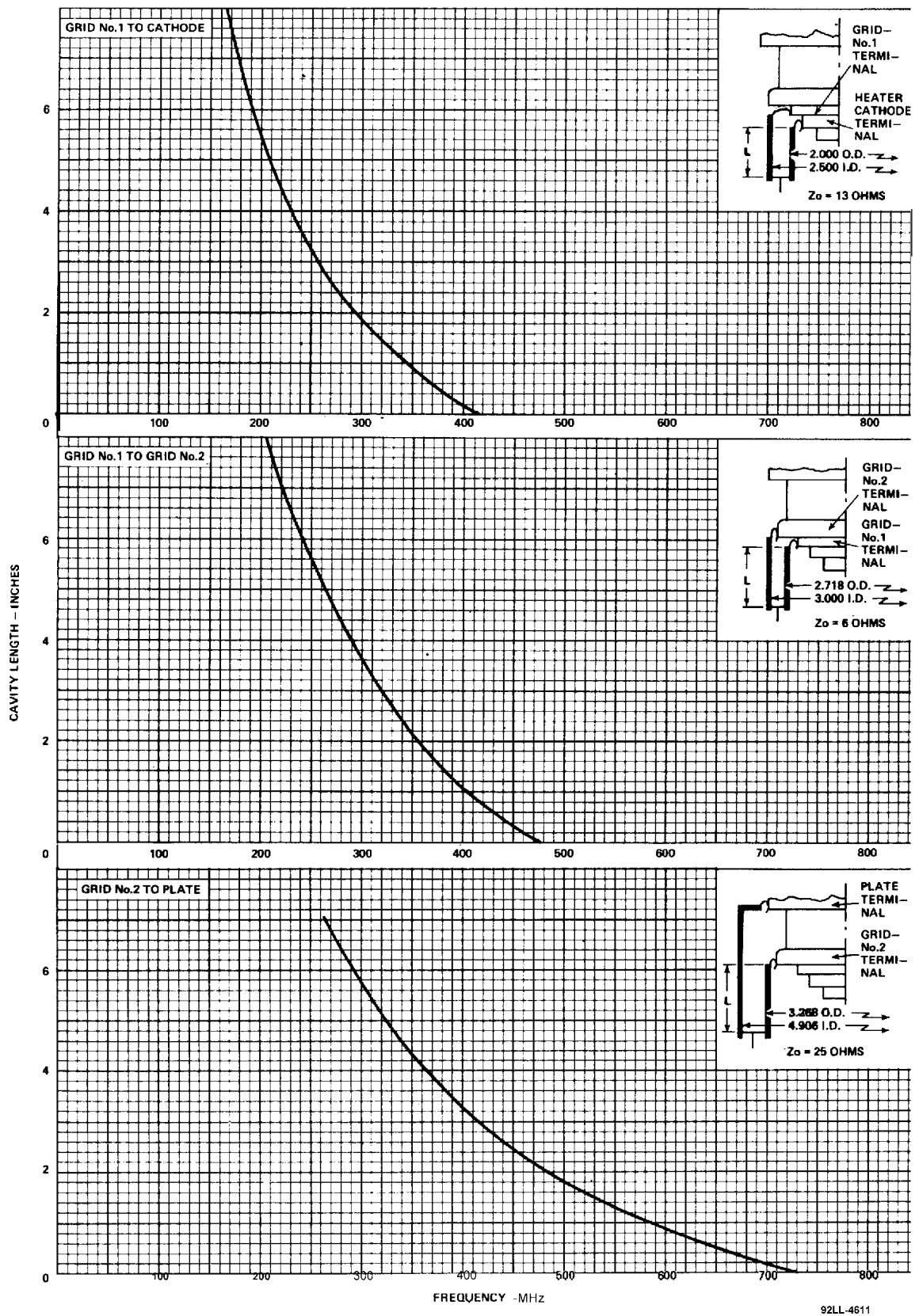

92LL-4611

Figure 9 -Tuning Characteristics

Tube Removal From Socket (Suggested Design)

The tube should not be removed from the socket by rocking the tube back and forth. This motion crushes the contact fingers and applies undue force to the internal structure of the tube.

It is recommended that the tube be removed from the socket with an assembly similar to that shown in **Figure 10**. The extractor portion should be constructed with the dimensions shown in **Figure 11**.

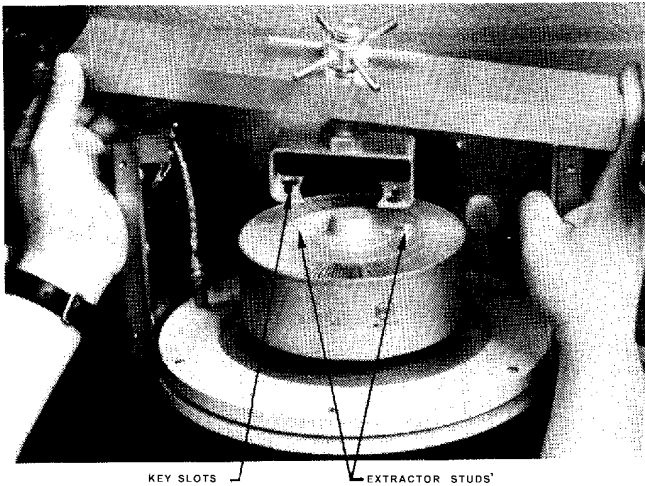
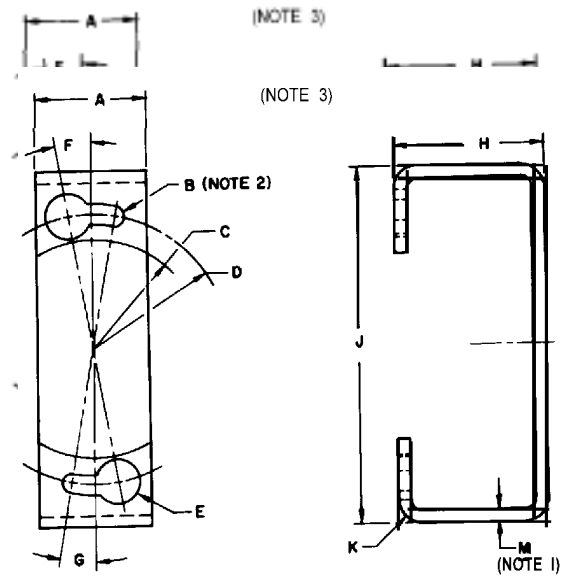

Figure 10 - Tube Puller J15449 for Use with BURLE Tube Type 8806



92LS - 2250

Figure 11 - Tube Extractor (Suggested Design)

- Note 1** - Material 1/8" thick cold rolled steel
- Note 2** - Round all edges
- Note 3** - Slot between holes

Tabulated Dimensions*

Dimension	Value		
A	30.48	(1.20)	
B	5.080 +1.27	(0.200 ± .005)	Dia.
C	29.21	(1.15)	Radius
D	36.83	(1.45)	Radius
E	11.430 + .127	(0.450 ± .005)	Dia.
F	0.175 Radian	(100)	
G	0.175 Radian	(100)	
H	40.64	(1.60)	
J	96.52	(3.80)	
K	6.4	(1/4)	Radius
M	3.2	(1/8)	Radius
*	Dimensions in millimeters. Dimensions in parentheses are in inches		